

Article number: 03554040

Description: Fluro hydraulic rod end FMA 40D

Measures

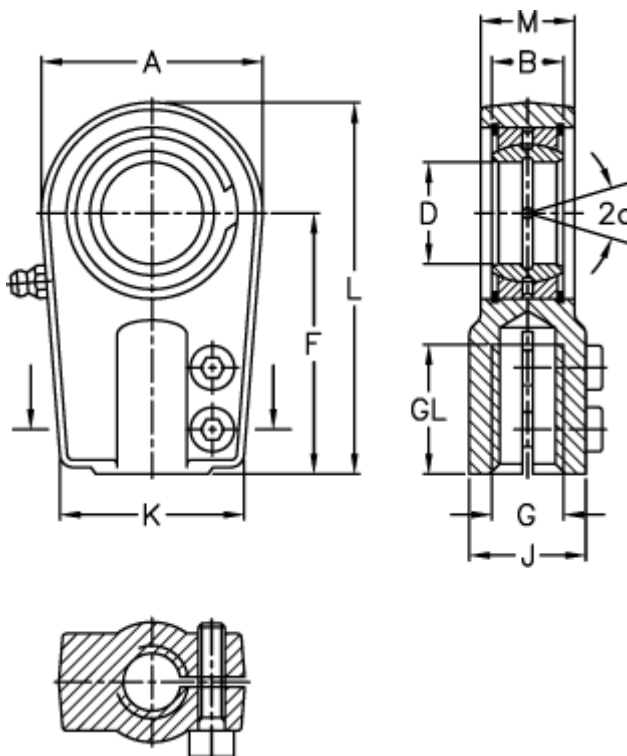

A	= 94	J	= 55
a (degrees)	= 7	K	= 78
B	= 28	L	= 155
D	= 40	M	= 35
Dynamic load C (kN)	= 140	Static load C0 (kN)	= 297
F	= 105	Torque (N m)	= 80
g	= M39x3	Weight	= 2400
GL	= 55		